

Intellimod™ Module MAXISS Series™ Multi AXIS Servo IPM 150 Amperes/600 Volts

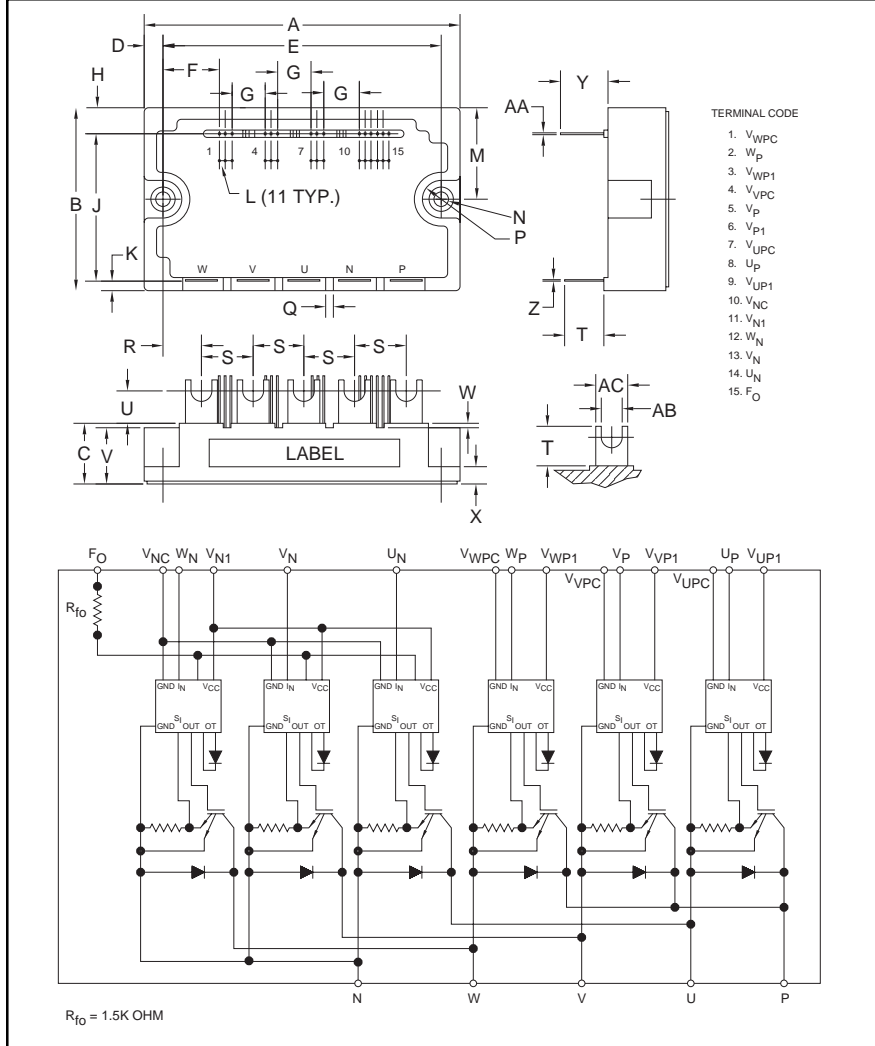

Description:

Powerex Intellimod™ Intelligent Power Modules are isolated base modules designed for power switching applications operating at frequencies to 20kHz. Built-in control circuits provide optimum gate drive and protection for the IGBT and free-wheel diode power devices.

Features:

- Complete Output Power Circuit
- Gate Drive Circuit
- Protection Logic
 - Short Circuit
 - Over Current
 - Under Voltage
 - Over Temperature by On-Chip Temperature Sensor
- Low Loss Using 4th Generation IGBT Chip

Applications:

- Motion Control
- Servo Control

Ordering Information:

Example: Select the complete part number from the table below -i.e. PM100CBS060 is a 600V, 100 Ampere Intellimod™ Intelligent Power Module.

Type	Current Rating Amperes	V_{CES} Volts (x 10)
PM	150	060

Outline Drawing and Circuit Diagram

Dimensions	Inches	Millimeters
A	4.72	120.0
B	1.97	50.0
C	1.18	30.0
D	0.3	7.0
E	4.17±0.1	106.0±0.3
F	0.94	23.79
G	0.40	10.16
H	0.34	8.5
J	1.54	39.0
K	0.10	2.5
L	0.10	2.54
M	0.98	25.0
N	5.5 Dia.	Dia 5.5
P	0.28 Rad.	Rad. 7.0

Dimensions	Inches	Millimeters
Q	0.12	3.0
R	0.59	15.0
S	0.75	19.0
T	0.39	10.0
U	0.24	6.0
V	1.10	28.0
W	0.08	2.0
X	0.26	6.5
Y	0.43	11.0
Z	0.04	1.0
AA	0.03	0.64
AB	0.20	5.0
AC	0.35	9.0

PM150CBS060
Intellimod™ Module
MAXISS Series™, Multi AXIS Servo IPM
 150 Amperes/600 Volts

Absolute Maximum Ratings, $T_j = 25^\circ\text{C}$ unless otherwise specified

Characteristics	Symbol	PM150CBS060	Units
Storage Temperature	T_{stg}	-40 to 125	$^\circ\text{C}$
Case Operating Temperature*	T_C	-20 to 100	$^\circ\text{C}$
Mounting Torque, M5 Mounting Screws	—	31	in-lb
Mounting Torque, M5 Main Terminal Screws	—	31	in-lb
Module Weight (Typical)	—	400	Grams
Supply Voltage Protected by OC and SC ($V_D = 13.5 - 16.5\text{V}$, Inverter Part, $T_j = 125^\circ\text{C}$)	$V_{CC(prot.)}$	400	Volts
Supply Voltage, Surge (Applied between P - N)	$V_{CC(surge)}$	500	Volts
Isolation Voltage, AC 1 minute, 60Hz Sinusoidal	V_{ISO}	2500	V_{rms}

IGBT Inverter Sector

Collector-Emitter Voltage ($V_D = 15\text{V}$, $V_{CIN} = 15\text{V}$)	V_{CES}	600	Volts
Collector Current, \pm ($T_C = 25^\circ\text{C}$)	I_C	150	Amperes
Peak Collector Current, \pm ($T_C = 25^\circ\text{C}$)	I_{CP}	300	Amperes
Collector Dissipation	P_C	735	Watts
Power Device Junction Temperature	T_j	-20 to 150	$^\circ\text{C}$

Control Sector

Supply Voltage Applied between ($V_{UP1}-V_{UPC}$, $V_{VP1}-V_{VPC}$, $V_{WP1}-V_{WPC}$, $V_{N1}-V_{NC}$)	V_D	20	Volts
Input Voltage Applied between (U_P-V_{UPC} , V_P-V_{VPC} , W_P-V_{WPC} , U_N-V_{NC} , W_N-V_{NC})	V_{CIN}	20	Volts
Fault Output Supply Voltage (Applied between F_O and V_{NC})	V_{FO}	$V_D + 0.5$	Volts
Fault Output Current (Sink Current at F_O Terminal)	I_{FO}	20	mA

* T_C Measure Point (Under the Chip)

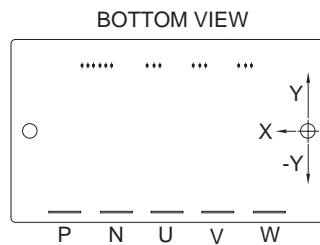

(mm)

ARM \ AXIS	U_P		V_P		W_P		U_N		V_N		W_N	
	IGBT	FWDi	IGBT	FWDi	IGBT	FWDi	IGBT	FWDi	IGBT	FWDi	IGBT	FWDi
X	83.3	83.3	41.8	41.8	16.8	16.8	70.8	70.8	54.3	54.3	29.3	29.3
Y	5.3	-4.8	5.3	-4.8	5.3	-4.8	-0.8	-10.8	-0.8	-10.8	-0.8	-10.8



Powerex, Inc., 200 Hillis Street, Youngwood, Pennsylvania 15697-1800 (724) 925-7272

PM150CBS060
Intellimod™ Module
MAXISS Series™, Multi AXIS Servo IPM
 150 Amperes/600 Volts

Electrical and Mechanical Characteristics, $T_j = 25^\circ\text{C}$ unless otherwise specified

Characteristics	Symbol	Test Conditions	Min.	Typ.	Max.	Units
IGBT Inverter Sector						
Collector-Emitter Cutoff Current	I_{CES}	$V_{CE} = V_{CES}, V_D = 15V, T_j = 25^\circ\text{C}$	—	—	1.0	mA
		$V_{CE} = V_{CES}, V_D = 15V, T_j = 125^\circ\text{C}$	—	—	10	mA
Diode Forward Voltage	V_{EC}	$-I_C = 150A, V_D = 15V, V_{CIN} = 15V$	—	2.2	3.3	Volts
Collector-Emitter Saturation Voltage	$V_{CE(sat)}$	$V_D = 15V, V_{CIN} = 0V, I_C = 150A,$ $T_j = 25^\circ\text{C}$	—	1.7	2.3	Volts
		$V_D = 15V, V_{CIN} = 0V, I_C = 150A,$ $T_j = 125^\circ\text{C}$	—	1.7	2.3	Volts
Inductive Load Switching Times	t_{on}		0.8	1.2	2.4	μS
	t_{rr}	$V_D = 15V, V_{CIN} = 0 \sim 15V,$	—	0.15	0.3	μS
	$t_{C(on)}$	$V_{CC} = 300V, I_C = 150A,$	—	0.4	1.0	μS
	t_{off}	$T_j = 125^\circ\text{C}, \text{Inductive Load}$	—	2.4	3.3	μS
	$t_{C(off)}$		—	0.5	1.0	μS
Control Sector						
Over Current Trip Level	OC	$T_j = -20^\circ\text{C}, V_D = 15V$	—	—	690	Amperes
		$T_j = 25^\circ\text{C}, V_D = 15V$	286	404	570	Amperes
		$T_j = 125^\circ\text{C}, V_D = 15V$	210	—	—	Amperes
Short Circuit Trip Level	SC	$-20^\circ\text{C} \leq T_j \leq 125^\circ\text{C}, V_D = 15V$	—	420	—	Amperes
Over Current Delay Time	$t_{off(OC)}$	$V_D = 15V$	—	10	—	μS
Over Temperature Protection	OT	Trip Level	135	145	155	$^\circ\text{C}$
(Detect T_j of IGBT Chip)	OT_R	Reset Level	—	125	—	$^\circ\text{C}$
Supply Circuit Under Voltage Protection	UV	Trip Level	11.5	12.0	12.5	Volts
	UV_R	Reset Level	—	12.5	—	Volts
Circuit Current	I_D	$V_D = 15V, V_{CIN} = 15V, V_{N1} \sim V_{NC}$	—	45	65	mA
		$V_D = 15V, V_{CIN} = 15V, V_{XP1} \sim V_{XPC}$	—	15	20	mA
Input ON Threshold Voltage	$V_{th(on)}$	Applied between $U_P \sim V_{UPC}, V_P \sim V_{VPC},$	1.2	1.5	1.8	Volts
Input OFF Threshold Voltage	$V_{th(off)}$	$W_P \sim V_{WPC}, U_N, V_N, W_N \sim V_{NC}$	1.7	2.0	2.3	Volts
Fault Output Current	$I_{FO(H)}$	$V_D = 15V, V_{FO} = 15V$	—	—	0.01	mA
	$I_{FO(L)}$	$V_D = 15V, V_{FO} = 15V$	—	10	15	mA
Minimum Fault Output Pulse Width	t_{FO}	$V_D = 15V$	1.0	1.8	—	mS



Powerex, Inc., 200 Hillis Street, Youngwood, Pennsylvania 15697-1800 (724) 925-7272

PM150CBS060
Intellimod™ Module
MAXISS Series™, Multi AXIS Servo IPM
 150 Amperes/600 Volts

Thermal Characteristics

Characteristic	Symbol	Condition	Min.	Typ.	Max.	Units
Junction to Case Thermal Resistance	$R_{th(j-c)Q}$	Each IGBT*	—	—	0.17**	°C/Watt
	$R_{th(j-c)F}$	Each FWDI*	—	—	0.27**	°C/Watt
Contact Thermal Resistance	$R_{th(c-f)}$	Case to Fin Per Module, Thermal Grease Applied	—	—	0.046	°C/Watt

* T_C measured point is just under the chips.

**If you use this value, $R_{th(f-a)}$ should be measured just under the chips.

Recommended Conditions for Use

Characteristic	Symbol	Condition	Value	Units
Supply Voltage	V_{CC}	Applied across P-N Terminals	≤ 400	Volts
Control Supply Voltage*	V_D	Applied between $V_{UP1}-V_{U1PC}$, $V_{VP1}-V_{V1PC}$, $V_{WP1}-V_{W1PC}$, $V_{N1}-V_{N1C}$	15 ± 1.5	Volts
Input ON Voltage	$V_{CIN(on)}$	Applied between U_P-V_{U1PC} , V_P-V_{V1PC} ,	≤ 0.8	Volts
Input OFF Voltage	$V_{CIN(off)}$	W_P-V_{W1PC} , U_N , V_N , W_N-V_{N1C}	≥ 4.0	Volts
PWM Input Frequency	f_{PWM}	Using Application Circuit	≤ 20	kHz
Minimum Dead Time	t_{DEAD}	Input Signal	≥ 2.5	μS

*With ripple satisfying the following conditions: $dv/dt \leq \pm 5v/\mu s$, Variation $\leq 2V$ peak to peak.

PM150CBS060
Intellimod™ Module
MAXISS Series™, Multi AXIS Servo IPM
 150 Amperes/600 Volts

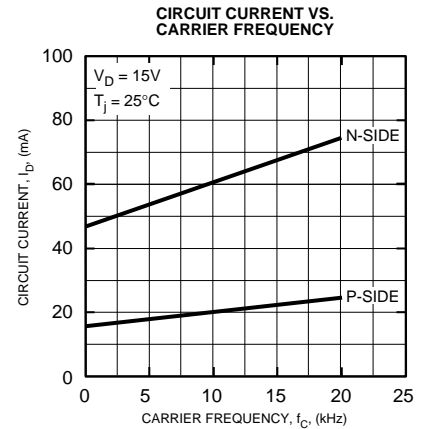
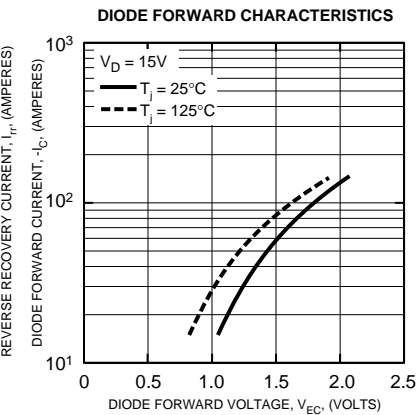
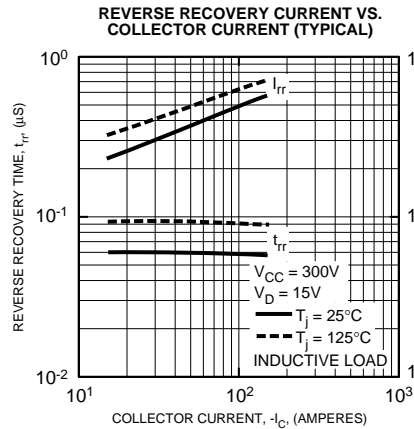
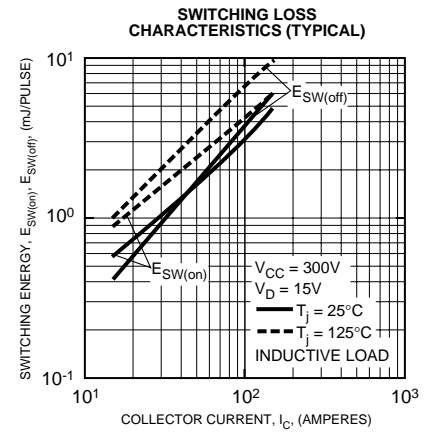
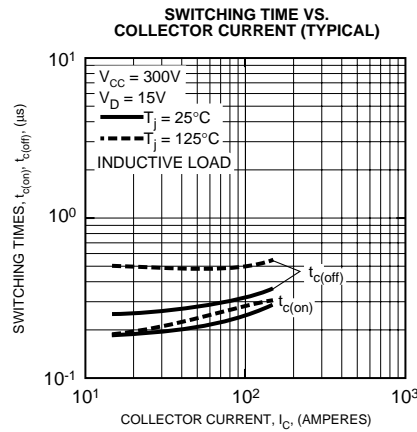
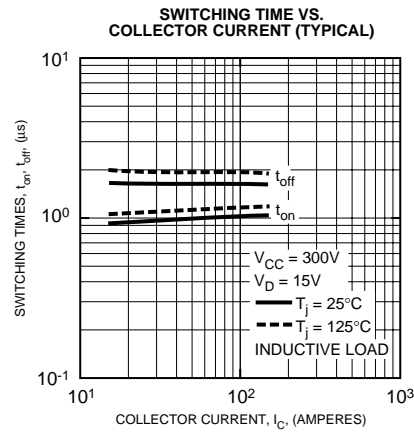
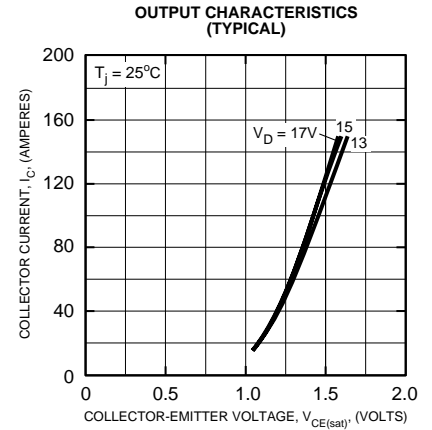
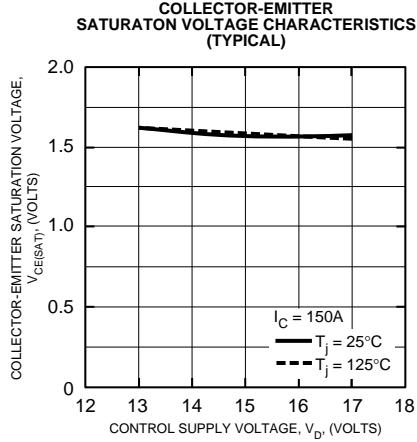
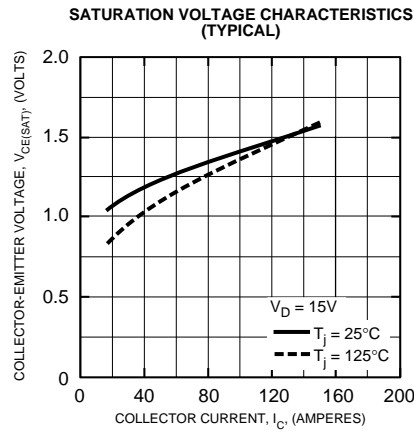



Powerex, Inc., 200 Hillis Street, Youngwood, Pennsylvania 15697-1800 (724) 925-7272

PM150CBS060
Intellimod™ Module
MAXISS Series™, Multi AXIS Servo IPM
 150 Amperes/600 Volts

